

Aire



A symbol for unity!

—
The Aire collection is a light and adaptable range of tables and work benches. Synonymous to its design is a consistent design aesthetic, which supports the changing work landscape by providing flexibility in purpose.

schiaavello

The Knowledge collection

Schiavello's Knowledge collection comprises of cutting-edge products that are based on extensive research conducted by our Schiavello Design Studio and People and Culture Consulting teams. Led by strategic research into how businesses and employees function, these products help achieve goals and solve problems within the workspace furniture industry.

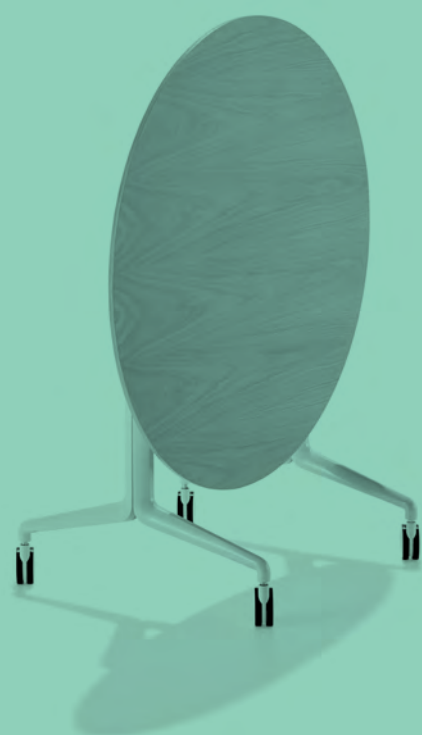

Contents

Designer

3 — 4

Workplace landscapes

7 — 8

Connection through harmony

9 — 10

Elegant and functional

13 — 14

Light aesthetic, strong performance

15 — 16

Flexible design

17 — 18

Aire Media Stand

19 — 20

Specifications

21 — 28

Accessories

29 — 34

ColourLab finishes

35 — 39

MARIO RUIZ

Mario Ruiz has a 20-year product design career that spans furniture, technology, lighting, office and applied graphics.

A graduate in industrial design from the Elisava School of Design in Barcelona, Mario's skill and multidisciplinary experience has seen him collaborate with in excess of 120 diverse companies worldwide on over 600 projects.

Mario has been acknowledged with more than 40 prestigious awards in Europe and the United States, including IF Awards, Red Dot, Design Plus, Wallpaper Awards '08 and Neocon Awards '08. For over 10 years, Mario has also lectured at the Eina and Elisava design schools in Barcelona. "Design in few words: who says a lot with very little," guides Mario's design sensibility.



Introducing Aire

Workplace landscapes



The Aire collection of work benches, meeting and fold tables was realised by Spanish designer Mario Ruiz in response to a progressive work landscape. Accommodating individual needs and team environments, Aire's flexible design and customisation abilities transform spaces to support an array of working philosophies, including collaboration, retreat, formal and informal communication, to name a few.

Connection through harmony

Aire's harmonious design aesthetic echoes throughout the range and encourages a sense of connection between the user and the physical space they reside. A sense of connection within a supportive team culture can elicit feelings of belonging, which research suggests encourages engagement and productivity – unifying the needs of both the organisation and the individual worker and enabling a purposeful relationship to exist between the two.





Elegant and functional

Aire's subtle cable management complements various electrification preferences by delicately enclosing wires within an upholstered mesh cover. The collection is compatible with a range of worktops, while panels, accessories and fold tables are available in meeting and training room settings.

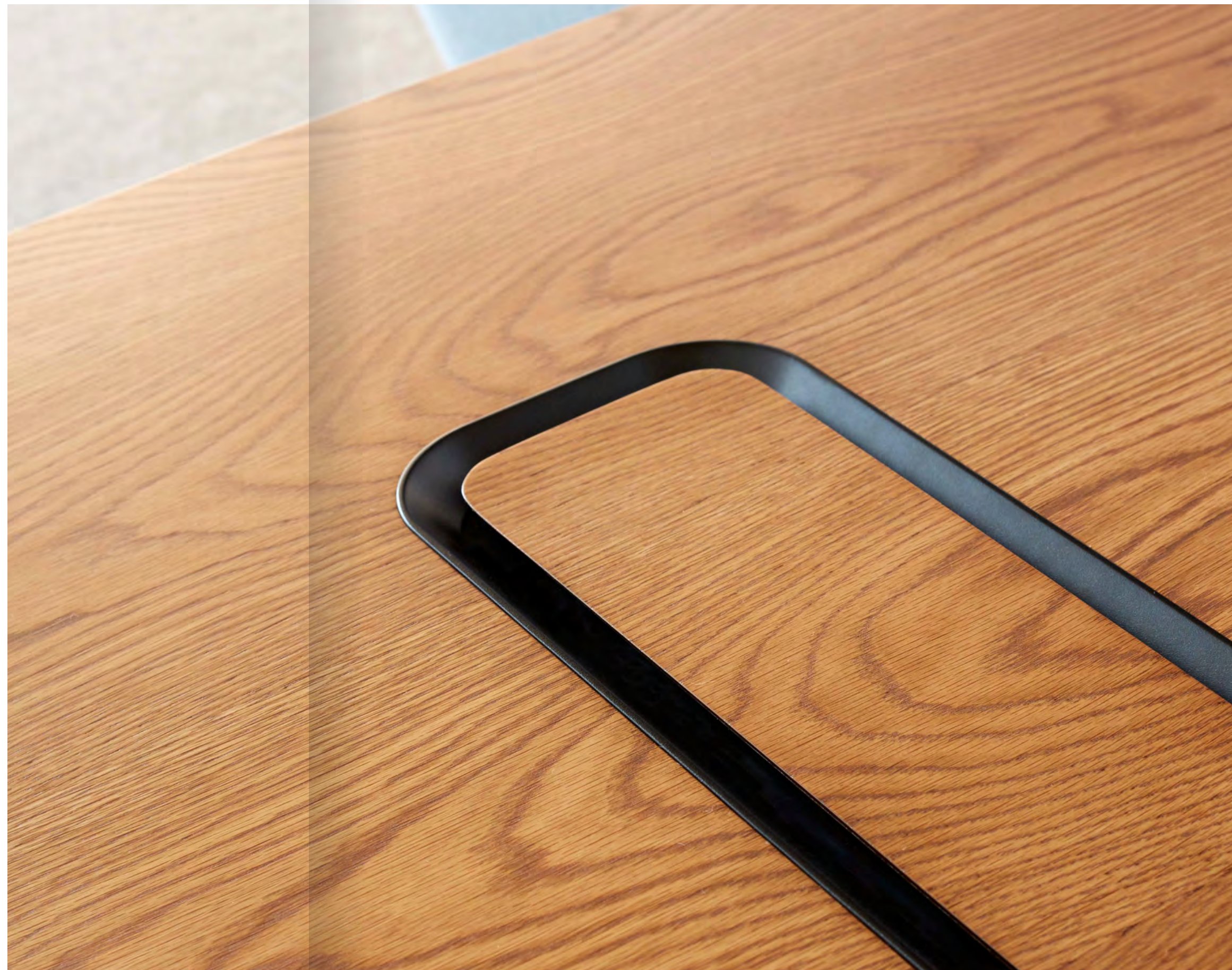

Light aesthetic, strong performance

Sharing common geometry throughout the collection, Aire couples light dexterity with strong performance through high-quality aluminum and engineering. Splayed and straight leg options feature cast aluminium and steel support beams, able to support a 3m length top with only four legs. Aire's slender tabletops are available in soft edged radiuses or rectangular shapes and are available in a multitude of finishes, enabling visual customisation within various work settings.



A 315mm worktop overhang supports collaborative situations.

Couple Aire Work Benches with the Scope range of rails, above desk shelves and storage to support various user requirements.

A seamless understructure eliminates leg obstructions, providing a space for storage and work accessories.

Strong and lightweight aluminium legs and steel support beams allow Aire tabletops to span 3000mm (118") with only four legs.

Flexible design



Echoing the elegant and light profile known to the Aire collection, the Aire Fold Table offers a flexible solution to contemporary and agile-based working, training and meeting settings. Featuring a highly engineered tilt mechanism, the tabletop is able to conveniently and safely fold vertically after use. Additionally, four lockable castors make its slender form easy to move between aisles, doorways, elevators and into storage compartments.



Aire Media Stand

The Aire Media Stand enables presentations, video chats, screen mirroring and video capabilities. While embodying the visually light and delicate aesthetic of the Aire range. With a light touch, it transforms meeting and working spaces for enhanced collaboration and communication.



Specifications

Specifications

Work Bench

Linear Work Bench

Four leg

1500mm-1800mm / 59.1"-70.9" W
1200mm-3000mm / 47.4"-118.1" L
720mm / 28.3" H

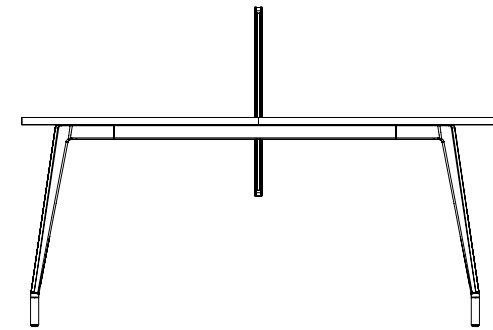

Shared leg

1500mm-1800mm / 59.1"-70.9" W
2400mm-7500mm / 94.5"-295.3" L
720mm / 28.3" H

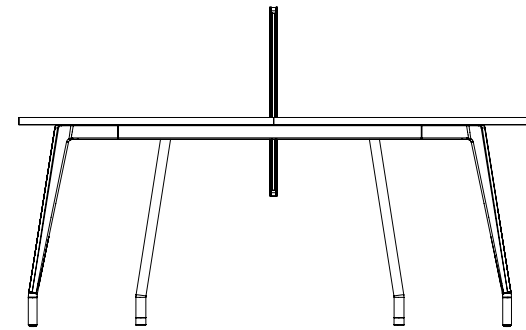

90° Work Bench

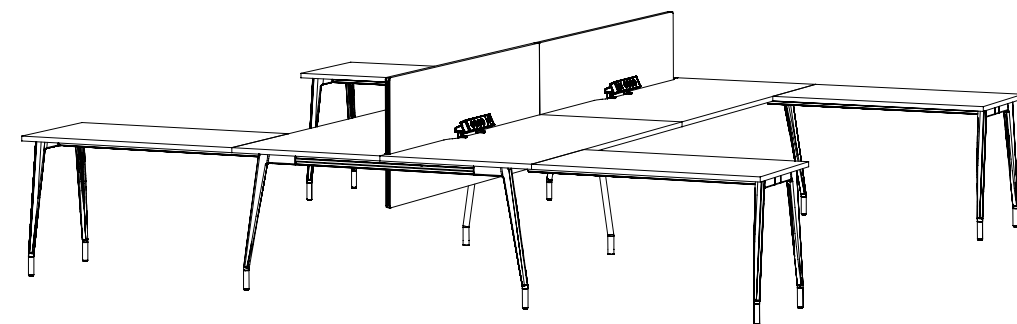

Linear
1500mm - 1800mm / 59.1"-70.9" W
1200mm - 2400mm / 47.2"-94.5" L
720mm / 28.3" H

Return
600mm-700mm / 23.6"-27.6" W
900mm-1600mm / 35.4"-63" L
720mm / 28.3" H

Executive Desk

Executive

Aire can be coupled with Schiavello storage units to create thoughtful and considered executive settings.

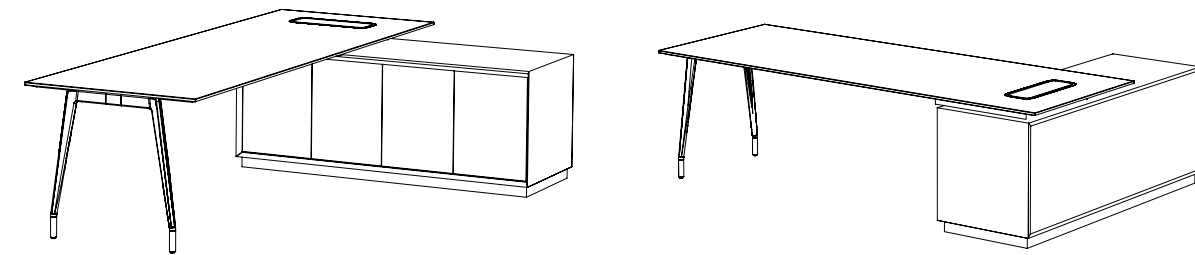

Meeting

Glide

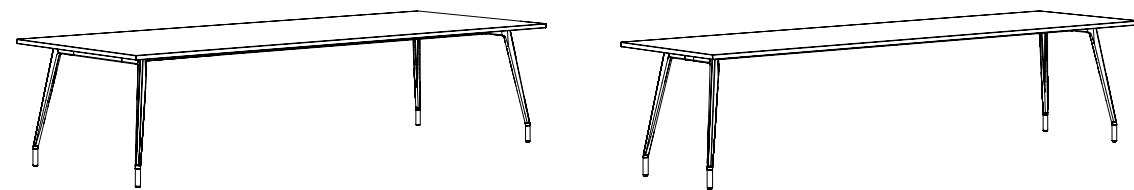

900mm-1200mm / 35.4"-47.2" W
 900mm-3000mm / 35.4"-118.1" L
 720mm / 28.3" H
 minimum 150mm / 5.9" overhang
 maximum 315mm / 12.4"

Castor

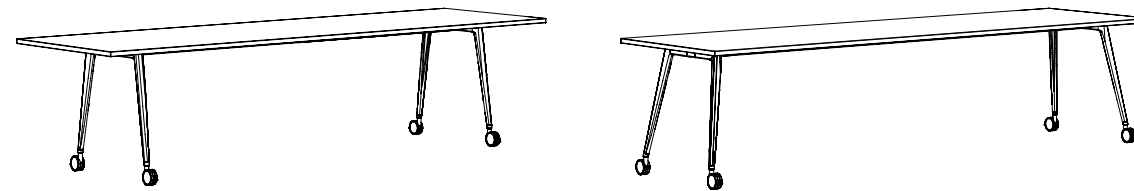

900mm-1200mm / 35.4"-47.2" W
 900mm-3000mm / 35.4"-118.1" L
 720mm / 28.3" H
 minimum 150mm / 5.9" overhang
 maximum 315mm / 12.4"

Pad

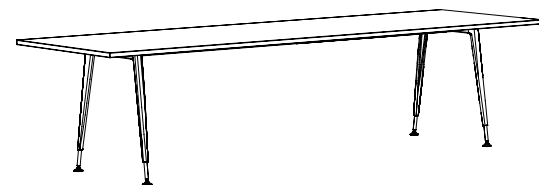

900mm-1200mm / 35.4"-47.2" W
 900mm-3000mm / 35.4"-118.1" L
 720mm / 28.3" H
 minimum 150mm / 5.9" overhang
 maximum 315mm / 12.4"

Fold

Training



850mm-950mm / 33.5"-37.4" W
 1600mm-2400mm / 63"-94.5" L
 720mm / 28.3" H
 available with a 60mm-200mm / 2.4"-7.9" inset from edge

Meeting



1000mm-1200mm / 39.4"-47.2" W
 1600mm-2400mm / 63"-94.5" L
 720mm / 28.3" H
 available with a 60mm-200mm / 2.4"-7.9" inset from edge

Options

Splayed leg

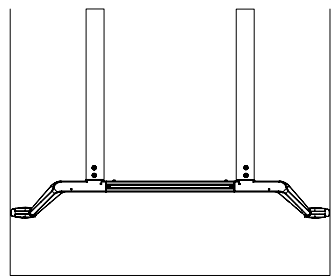

Straight leg

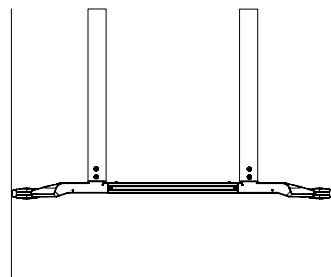

Cable tray

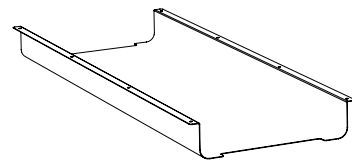

Pad

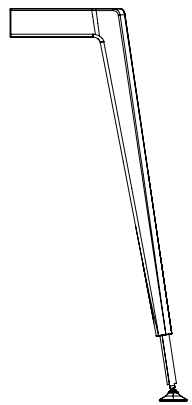

Glide

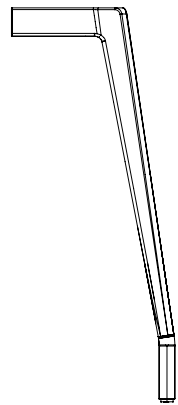

Castor

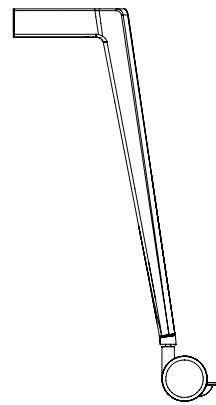

Aire Media Stand

Aire Media Stand

1530mm / 60.2" W
865mm / 34.4" L
1715mm / 67.5" H

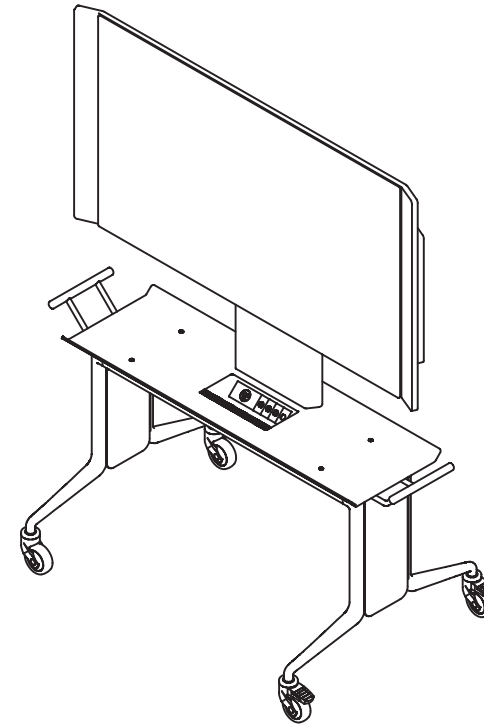

Accessories

Panels

Schiavello system panels are a sturdy design built to be floor or desk-mounted and are available in a choice of fabric, PET, MDF, veneer, glass or metal.

System 45 Panel 45mm thick



System 30 Panel 30mm thick



System 18 Panel 18mm thick



Vide Panel 25mm thick



Lettric

Designed in-house by Schiavello, Lettric is a collection of various electrification options. Available in the Schiavello ColourLab powder coat range, Lettric features aluminium housing that enables personalisation and neat cable management.

Above-Desk Service Module



In-Desk Service Module



Outlet Housing Module



Below-Desk Service Module



Scope Accessory Rail

The Scope Accessory Rail attaches to any desk via a bracket, which is screwed into the worktop. Accessories such as Scope Shelves, Modesty Panels, Privacy Panels and power outlets attach to the Accessory Rail or clamp directly to the worktop, and can easily be changed and moved with minimal tools. The sleek and lightweight design avoids the dominating aesthetics often linked to systems panels and boosts functionality by giving users freedom to maximise valuable desk real estate.

Scope



Bento

Keep your desk in order with the Bento storage solution. The Bento collection includes a landscape paper tray and a container tray with five multifunctional, modular containers which can be placed within the tray or as standalone elements.

Bento Box

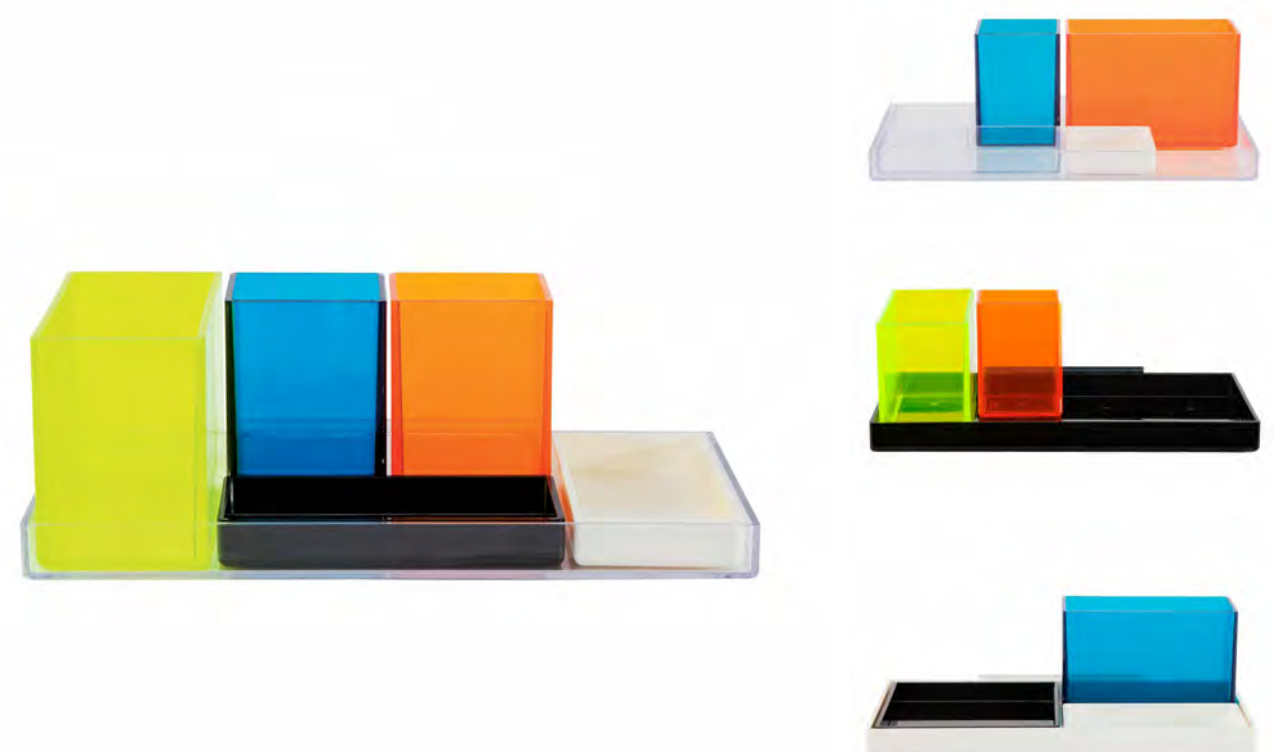

Aire Media Stand

Bring audiovisual capabilities to the table with the Aire Media Stand. Weighted to hold virtually any screen up to 100kg, the unit is strong and longwearing. Despite this, it shares the elegant and lightweight design language synonymous with the Aire collection.

Every detail has been considered. Four large castors combine with handles to make moving the stand effortless. Meanwhile, the unit's tabletop leaves space to rest a tablet or laptop, while a cable cubby keeps all cables tidy and out of the way.

Aire Media Stand



Castors



Handle and generous tabletop



Safety switch



Built-in power



ColourLab

ColourLab

Schiavello's innovative ColourLab brings a considered and cohesive palette of finishes to working and living spaces. Curated by Giulio Ridolfo and developed by Schiavello, the palette beautifully balances colour, texture and layering across a variety of materials.

Worktops

LAMINATE

LAMINATE 1.0 / Category 1

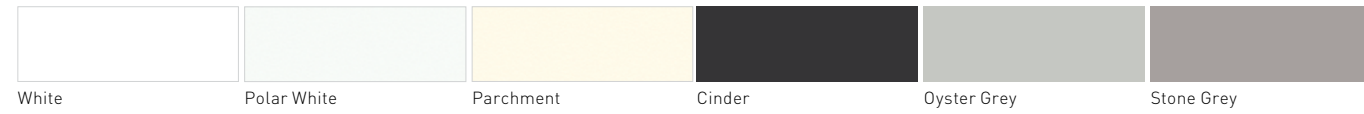

LAMINATE 1.0 / Category 2

LAMINATE 1.0 / Category 3

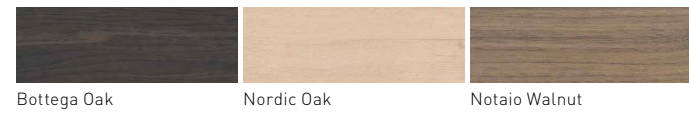

LAMINATE 1.1 / Category 1

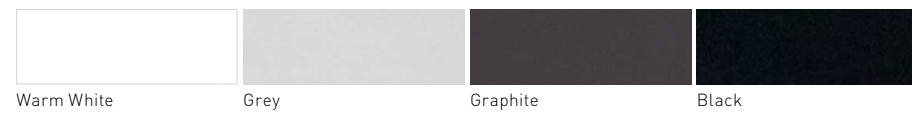

LAMINATE 1.1 / Category 2



SPOTLESS LAMINATE

SPOTLESS LAMINATE / Category 4



PLYWOOD

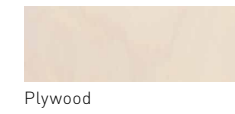

TIMBER NATURAL

Species



Applied finishes

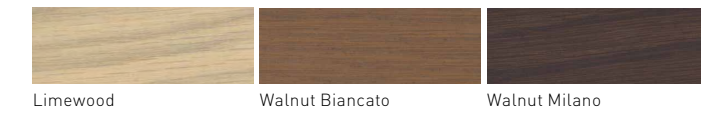

TIMBER PAINT



TIMBER WASH



Legs and understructure

FINISH

- Satin
- ‡ Texture

METAL POWDER COAT

METAL POWDER COAT / Category 1



METAL POWDER COAT / Category 2



METAL POWDER COAT / Category 3







Ecology and sustainability

Schiavello's most important commitment to sustainability is the company-wide Environmental Management System under ISO 14001. The environmental design principles realised means we design for the environment, focusing on efficient energy use and minimum emissions, longevity and durability, re-use and recycling of our products.

Our principles of ME WE (Materials, Energy, Waste Emissions) give us a simple way to think about how our operations impact the environment.

Printed on an Australian made paper stock that is PEFC Certified and made from elemental chlorine-free bleached pulp sourced from sustainably managed forests and non-controversial sources. It is manufactured by an ISO 14001 certified mill using renewable energy sources.



FS 604920

EMS 604919

About Schiavello

Schiavello is a multi-disciplinary company dedicated to developing intelligent, inspiring, ecological and resilient solutions for the office, the home and public spaces.

Schiavello's concepts and products are developed in Australia by applying a design process that brings together the company's core design principles and engineering with the creativity of local and international designers.

The Schiavello head office and world-class manufacturing facilities are integral to our continually developing rich tapestry of knowledge. This knowledge ultimately assists us in informing the right solutions and tools for each organisation's needs and people, allowing us to consistently achieve our philosophy that 'Anything is possible'.

To find a Schiavello Showroom or partner in your area, please visit [schiavellofurniture.com/find-us](https://www.schiavellofurniture.com/find-us)

All intellectual property rights and copyrights are reserved. Nothing contained in this brochure may be reproduced without written permission. Schiavello Group Pty Ltd reserves the right to change any or all details without prior notice. All dimensions stated within this document are nominal and/or approximate only and subject to variation.

SCH/AIR01-F

1 - Unity

Noun

The state of being united or joined as a whole.

2 - Unite

Verb

To come or bring together for a common purpose or action.



Synonymous to Aire's design is a consistent aesthetic.

www.schiavellofurniture.com/aire-table