

X-PRESS

X-PRESS, BECAUSE ERGONOMICS IS NOT A QUESTION OF SIZE.

Great ideas and the best thinking can happen even in smallest of spaces. The new X-PRESS desk not only fits in to any space but can also be perfectly adapted to individual needs; optimal working and ergonomic conditions are always possible, by way of three adjustable height settings. Whenever and wherever required X-PRESS can be used as a personal work desk. When not in use it can be quickly folded and neatly stored away, with just a flick of

the wrist. It's also well suited to workshop and project spaces, where people work together in teams as well as independently.

X-PRESS also provides the perfect foundation for the study or the bedroom, the desk cuts a fine figure anywhere, seamlessly blending into any interiors design scheme, thanks to a wide range of timeless colour finishes from the Bene spectrum.



bene

INSPIRING OFFICES. SINCE 1790.

PRODUCT DESCRIPTION

The distinctive powder-coated metal X-shaped frame always ensures stability, while the shapely tabletop provides ample space for all necessary work tools. Thanks to a wide range of timeless colour finishes, X-PRESS seamlessly blends into any interior design scheme.

- ❶ **Table top:** 16 mm chipboard, melamine or veneer
- ❷ **Frame:** available in different colours, see chapter „colours & materials“
- ❸ **Storage net:** black, enables cables and other personal items to be neatly stored away when both in the folded and unfolded position.
- ❹ **Synthetic material parts:** black

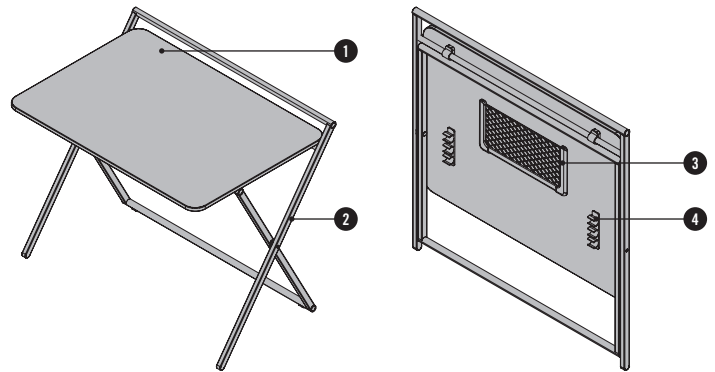

HEIGHTS

Tool-free height adjustment in three levels.

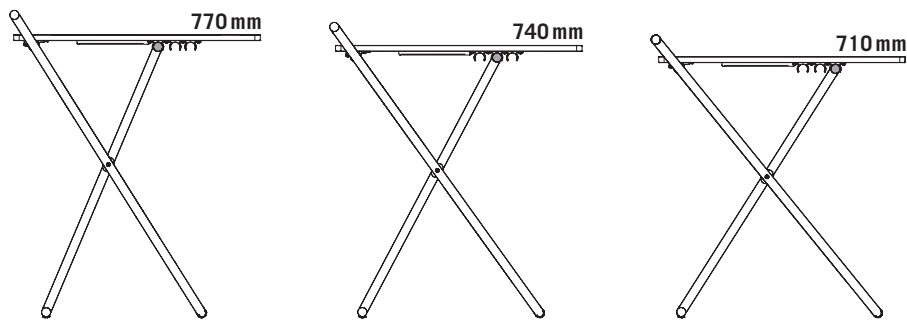

OVERVIEW & DIMENSIONS

X-PRESS

Table top
W: 956, D: 663

686

803

38

1.002

Folded position

127

982

Storage net

410

200

corners rounded, melamine: R 50 mm, veneer: R 70 mm

Dimensions in mm

INSPIRATIONS



Inspiration #01

X-PRESS

- Table top: melamine white
- Edge: white
- Frame: metal surface powder-coated, metallic green

Bay Chair

- Colour backrest/seat: Mainline Flax MLF12



Inspiration #02

X-PRESS

- Table top: melamine white
- Edge: laminated birch coloured
- Frame: metal surface powder-coated, white

Bay Chair

- Colour backrest/seat: Europost 66119



Inspiration #03

X-PRESS

- Table top: basalt
- Edge: basalt
- Frame: metal surface powder-coated, metallic blue

Bay Chair

- Colour backrest/seat: Mainline Flax MLF16



Inspiration #04

X-PRESS

- Table top: clay
- Edge: clay
- Frame: metal surface powder-coated, metallic brown

Bay Chair

- Colour backrest/seat: Mainline Flax MLF16

COLOURS & MATERIALS

MELAMINE: Basic colours¹

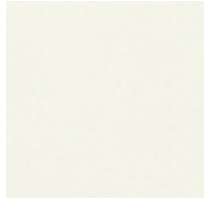

MW white

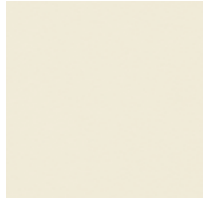

MQ office white

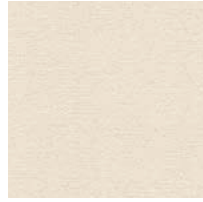

MC canvas

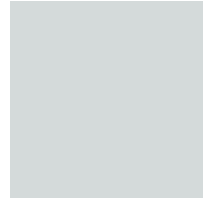

MP platinum



TM clay



MH stone grey



MA aluminium



MS slate



MB basalt



MD urban grey

MELAMINE: Additional basic colours¹

MELAMINE: Décor colours¹

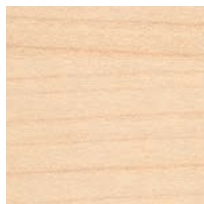

AR maple

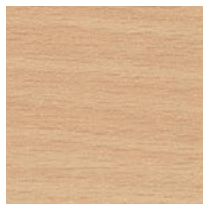

BH beech light

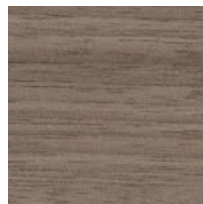

NG walnut grey

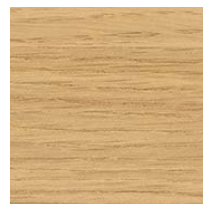

EZ oak vicenza

MELAMINE: Décor colours with texture¹



CE elm white



CO coco

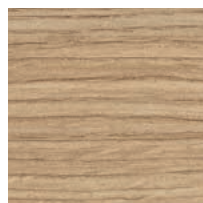

EA oak aragon

MELAMINE: Accent colours¹



TX mustard



TH marino blue



TS fern green

¹ only available with 2 mm mono-edge

COLOURS & MATERIALS

VENEER: Maple



AK canad. maple

VENEER: Beech



BG beech, grey

VENEER: Oak

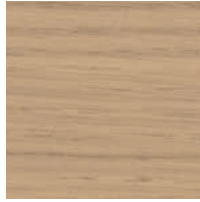

EY oak, silt

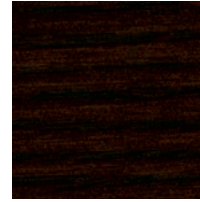

ER oak, amaretto

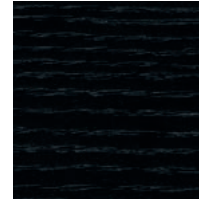

EV oak, volcano



EG oak grey

VENEER: Chestnut



KD chestnut natural



KP chestnut brown



KQ chestnut grey

VENEER: Walnut



NF americ. walnut



NR walnut, sienna



NB walnut, umbra

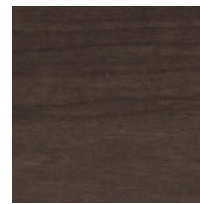

NA wal., anthracite

VENEER: Bamboo

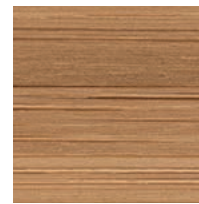

BJ bamboo

METAL SURFACE POWDER-COATED (FRAME)

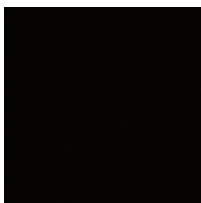

black

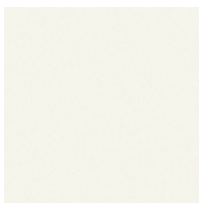

white



metallic green
68/50394



metallic brown
68/60835



matt blue
029/41112